

OPERATOR'S MANUAL

Nasal Adapter

0604-900106N

1st Edition: 27 Oct 2003

15th Edition: 22 Apr 2019

YG-120T/YG-121T/YG-122T

本品は、出荷される国や地域により仕様等が異なることがあります。
 ※日本向け製品については、日本語で記載しています。
 英語などその他の言語で記載されている内容は、日本以外に出荷される製品の説明です。

Some specifications of this product may differ depending on the destination country or region. Therefore descriptions in the Japanese manual and English and other language manuals may also differ.

本产品的部分规格可能因国家地区而有所不同。因此、日语、英语以及其他语言的说明书亦可能存在一定的差异。

Symbol	Description	Symbol	Description
	Caution		This way up
	Do not reuse		Fragile
	Date of manufacture		Keep away from rain
	Manufacturer	Rx Only	CAUTION: United States law restricts this product to sale by or on the order of a physician.
	Use by		
	Lot number	CE	The CE mark is a protected conformity mark of the European Community.
	European representative		
	Stacking limit by number		

General

The YG-120T, YG-121T or YG-122T nasal adapter is used with a TG-121T CO₂ sensor or TG-920P, TG-921T3 or TG-921T4 CO₂ sensor kit to measure the partial pressure of the expired CO₂ of the patient. YG-120T is for nasal breathing, YG-121T is for naso-oral breathing and YG-122T is for patients wearing an oxygen cannula.

Application

Dead space volume: 1.2 mL

For patients more than approx. 10 kg

This nasal adapter can be used with Nihon Kohden specified instruments which measure the partial pressure of the expired CO₂.

NOTE

Read the operator's manuals of the connected instrument and TG-920P, TG-921T3 or TG-921T4 CO₂ sensor kit together with this operator's manual.

Description of Parts

YG-120T
(for nasal breathing)

YG-121T
(for naso-oral)

YG-122T
(for oxygen cannula)

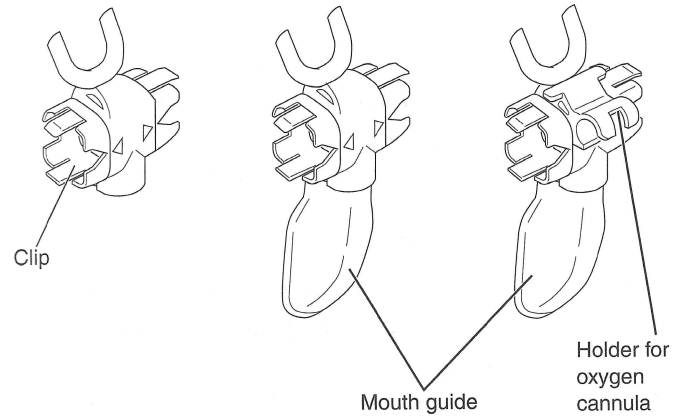

Safety Information

WARNING

When using the YG-120T, YG-121T or YG-122T nasal adapter on a patient with low ventilatory volume, check the ventilation taking into consideration the 1.2 mL dead space of the nasal adapter. If that dead space is too much for this patient, appropriate ventilation might be impossible. The CO₂ may mix in the inspiration due to the nasal adapter's dead space, resulting in inaccurate measured value or difficulty in detecting apnea.

WARNING

The only oxygen cannula that can be used with YG-122T is #1103 manufactured by Hudson RCI. Do not use any other oxygen cannula. Other oxygen cannulas cannot be attached and oxygen cannot be delivered to the patient through the nostrils.

WARNING

- When you use YG-122T together with an oxygen cannula, check that the oxygen cannula is correctly attached on the patient by referring to other parameters and by observing the patient periodically.
- If arterial oxygen partial pressure does not increase, immediately stop using the oxygen cannula with the CO₂ sensor kit and select another way to supply oxygen.

WARNING

Check that the oxygen cannula tube is not bent, broken, or blocked by the nasal tube. If the ends of the oxygen cannula tube turn too far up or down, it causes insufficient O₂ supply or the CO₂ value may be incorrect.

CAUTION

Only use the specified nasal adapter. Otherwise, the maximum performance cannot be guaranteed due to larger dead space volume.

CAUTION

The nasal adapter is non-sterilized and disposable. Use only for a single patient and single use. Failure to follow this instruction causes cross infection.

CAUTION

Use the nasal adapter with patients over 10 kg.

CAUTION

Do not use the nasal adapter for a neonate because the dead space volume of the nasal adapter is about 1.2 mL.

CAUTION

Do not use an nasal adapter which is past the expiration date.

CAUTION

Failure to follow the instructions below degrades the anti-fogging ability of the transparent film and results in incorrect measurement.

- Replace the nasal adapter with a new one every 24 hours.
- Replace the nasal adapter with a new one if blood, sputum or mucus adhere to the transparent film.
- Do not damage the transparent film. Do not let dust or detergent contact the transparent film. Do not touch, wipe or clean the transparent film with fingers or cleaners.

CAUTION

Do not let the patient bite or swallow the CO₂ sensor, airway adapter or nasal adapter.

CAUTION

When using the YG-121T or YG-122T nasal adapter on a patient, observe the patient condition all the time. The mouth guide touches the mouth and may cause pressure sores.

CAUTION

When measuring CO₂ partial pressure of a patient with an oxygen mask, set the oxygen supply to 5 L/min or more. If CO₂ gas remains in the oxygen mask and mixes with the inspired air, the measured value may be lower than the actual value.

CAUTION

United States law restricts this product to sale by or on the order of a physician.

NOTE

- Do not use surgical tape other than the provided tape because other types of tape easily come off with sweat and sebum. If the skin gets irritated from the surgical tape, stop using the surgical tape.
- Open the package just before use.
- Do not use a damaged or deformed nasal adapter.
- Do not dispose of the nasal adapter package until after using all the nasal adapters because the model and manufacturer are listed only on the package.

Attaching the Nasal Adapter

Hook the cable on the ears, and tape the cable on the cheek bone to keep it stable when talking.

NOTE

Be careful not to injure the patient's nostrils with the nasal tube.

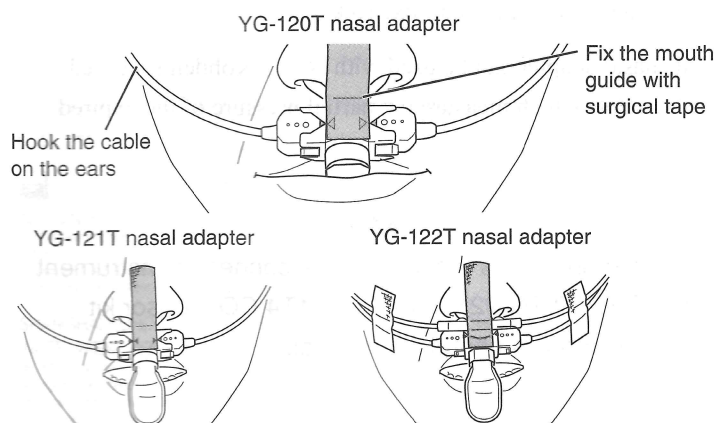

Attaching the Surgical Tape to the YG-120T Nasal Adapter

When using the YG-120T nasal adapter, do not cover the hole of the nasal adapter with the surgical tape. If the hole is covered, the measurement data will be incorrect because the expired air is blocked.

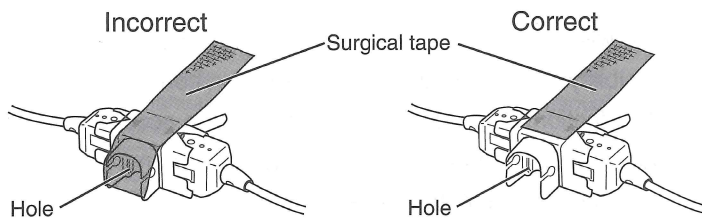

Fixing the YG-121T or YG-122T Nasal Adapter

Do not let the mouth guide touch the lips. Keep the distance between the mouth guide and the top of the mouth within 1 cm. CO₂ cannot be measured when the mouth guide is far from the mouth.

NOTE

Do not pull the mouth guide of the nasal adapter with excessive force. It may cause the nasal adapter to break.

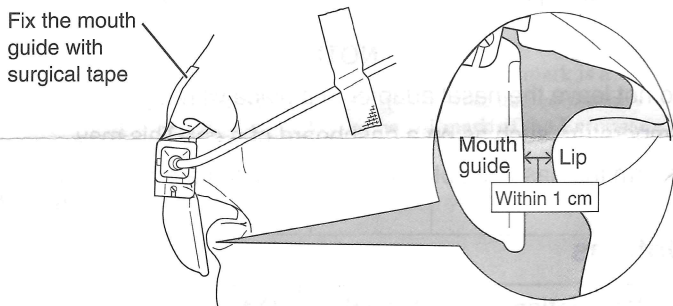

When Using the Nasal Adapter for a Patient with a Gastric Tube

Insert the nasal tube over the gastric tube or insert the nasal tube from beneath the gastric tube. When using a YG-120T nasal adapter (for nasal breathing), the nasal tube can be inserted only in the nostril which does not have the gastric tube.

Example of inserting nasal tube over the gastric tube

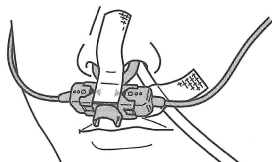

Example of inserting nasal tube in only one nostril (YG-120T only)

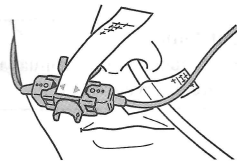

CAUTION

When using the nasal adapter for a patient with a gastric tube, fix the nasal adapter firmly to prevent pressing the intubation tube or disconnecting the nasal tube.

NOTE

Do not use the YG-121T nasal adapter (for naso-oral breathing) or YG-122T nasal adapter (for naso-oral breathing with an oxygen cannula) by inserting the nasal tube in only one nostril. Otherwise, correct measurement cannot be performed because the mouth guide will be away from the mouth.

Connecting the Oxygen Cannula

Connect the oxygen cannula to the nasal adapter so that the convex part of the oxygen cannula fits into the cutout in the cannula holder on the nasal adapter.

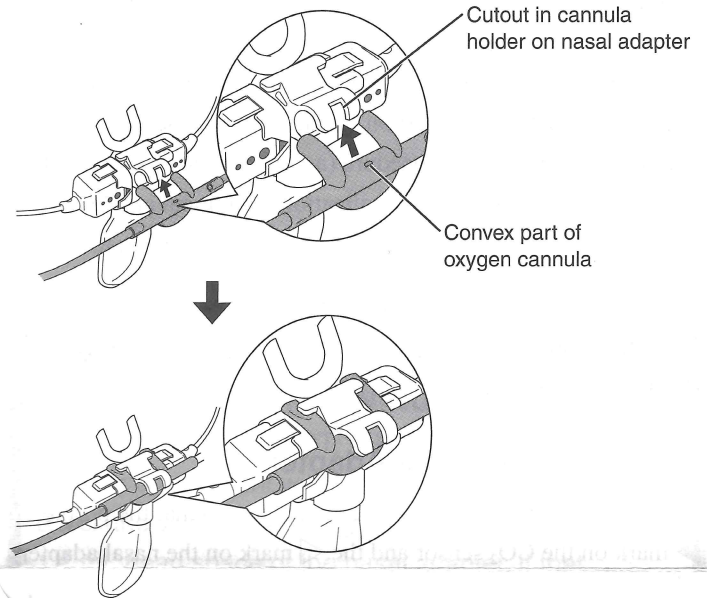

CAUTION

When using the CO₂ sensor kit with the oxygen cannula, set the oxygen supply to 5 L/min or lower. Otherwise, CO₂ cannot be correctly measured because the oxygen flow affects the expired gas flow.

NOTE

- Connect the oxygen cannula to the YG-122T nasal adapter before attaching the CO₂ sensor kit to the patient.
- If the oxygen cannula is installed backwards, the oxygen will be directly delivered into the nose which can cause distortion of the CO₂ waveform.
- When the oxygen cannula is installed correctly, the oxygen is delivered to the nose with the oxygen cannula so that the patient breathes the oxygen at the nose.
- Fix the oxygen cannula and nasal adapter to the patient with the provided surgical tape. Do not pull with force.

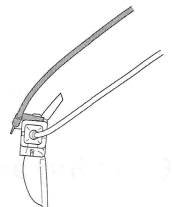

Sterilization (Before Use)

You can sterilize the nasal adapter with ethylene oxide gas only once and before use. Follow the sterilizing conditions below. The sterilizing conditions depend on the contamination of the adapter. Refer to the manual of the sterilizing equipment.

Gas:	EO 30% + CO ₂ 70%
EO concentration:	710 mg/L
Temperature:	45°C (113°F)
Relative humidity:	50%
Pressure:	-93.3 kPa to 49.1 kPa
Period:	4 to 10 hours

To remove the remaining gas from the nasal adapter after sterilization, first decrease the internal pressure of the sterilization equipment to -101.3 kPa (-760 mmHg) with a vacuum pump, then add carbon dioxide or antiseptic gas in the equipment. Repeat this procedure (aeration) at least 5 times. Take the nasal adapter out of the sterilization equipment and leave it for at least 6 days at 20°C (68°F) or more before using it.

NOTE

Do not autoclave the nasal adapter because this may damage the adapter.

Replacing the Nasal Adapter

Connect the CO₂ sensor to the nasal adapter so that the purple ► mark on the CO₂ sensor and the ◁ mark on the nasal adapter align. Insert the CO₂ sensor into the nasal adapter until it clicks. Refer to the operator's manual of the CO₂ sensor kit together with this manual.

Example: YG-120T

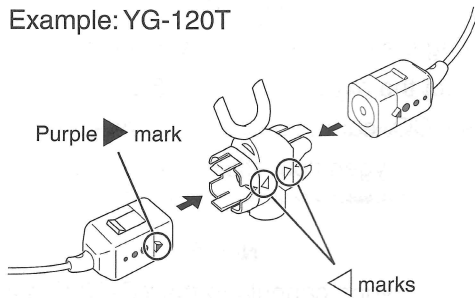

Pull the sensor part of the CO₂ sensor when removing the nasal adapter.

NOTE

Do not pull the CO₂ sensor cable. This may break the cable.

Cleaning and Disinfection

This nasal adapter is disposable. You can not clean or disinfect it. Immediately replace the nasal adapter with a new one when it becomes dirty.

Expiration Date

This nasal adapter is disposable. The expiration date is within 36 months including the month of manufacture.

Disposal

Dispose of the nasal adapter by following your local laws for disposing of infectious medical waste.

CAUTION

Dispose of Nihon Kohden products according to your local laws and your facility's guidelines for waste disposal. Otherwise, it may affect the environment. If there is a possibility that the product may have been contaminated with infection, dispose of it as medical waste according to your local laws and your facility's guidelines for medical waste. Otherwise, it may cause infection.

Environment

Operating Environment

Temperature:	0 to 45°C (32 to 113°F)
Humidity:	30 to 95% (noncondensing)
Atmospheric pressure:	70 to 106 kPa

Storage Environment

Temperature:	-20 to +65°C (-4 to +149°F)
Humidity:	10 to 90% (noncondensing)
Atmospheric pressure:	70 to 106 kPa

NOTE

Do not leave the nasal adapter in a place with high temperature such as on a dashboard of a car. This may deform the nasal adapter and cause inaccurate measurement.

Options

Description	Model	Q'ty	Supply Code
Surgical tape	#1527	24	Y242
Oxygen cannula*	#1103	25	V927A

* The only oxygen cannula that can be used with YG-122T is #1103 manufacture by Hudson RCI.

Note for users in the territory of the EEA and Switzerland:
Any serious incident that has occurred in relation to the device should be reported to the European Representative designated by the manufacturer and the Competent Authority of the Member State of the EEA and Switzerland in which the user and/or patient is established.

Copyright Notice

The entire contents of this manual are copyrighted by Nihon Kohden. All rights are reserved.

 Manufacturer
NIHON KOHDEN CORPORATION
1-31-4 Nishiiochiai, Shinjuku-ku,
Tokyo 161-8560, Japan
Phone +81 3-5996-8041
<https://www.nihonkohden.com/>

 European Representative
NIHON KOHDEN EUROPE GmbH
Raiffeisenstrasse 10, D-61191 Rostbach, Germany
Phone +49 6003-827-0 Fax +49 6003-827-599

SHANGHAI KOHDEN MEDICAL ELECTRONIC INSTRUMENT CORP.
No. 567 Huancheng Bei Road
Shanghai Comprehensive Industrial Development Zone
Fengxian District, Shanghai 201401, China
Phone +86 21-5743-6998 Fax +86 21-5743-6939

NIHON KOHDEN AMERICA, INC.
15353 Barranca Parkway, Irvine, CA 92618, U.S.A.
Toll-free +1-800-325-0283
Phone +1 949-580-1555 Fax +1 949-580-1550